

View Front side
1 : 50

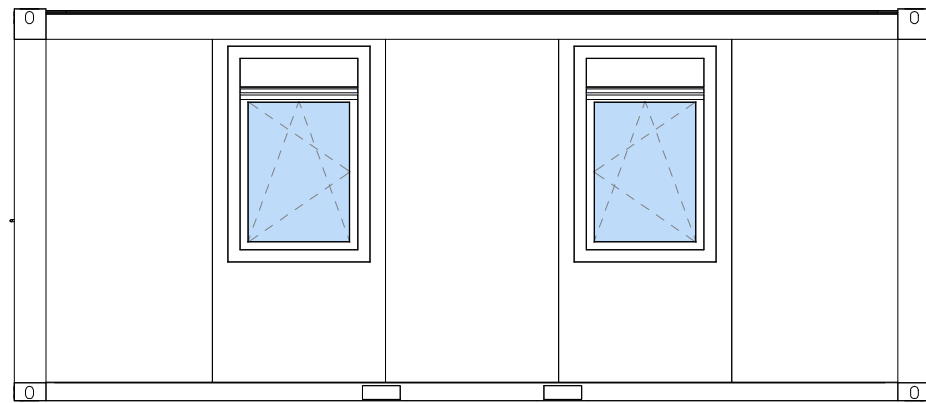

Floor Plan
1 : 50

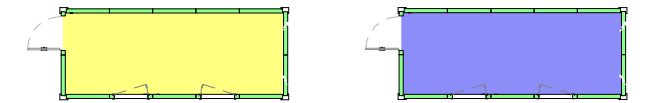
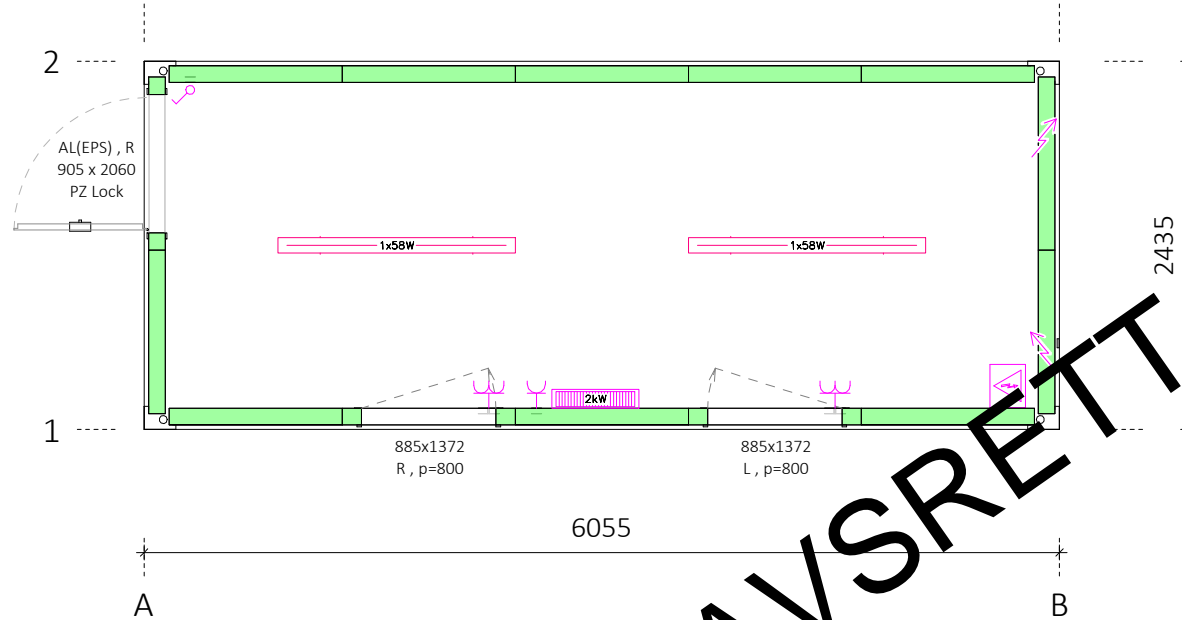

Floor plate
Chipboard

Floor covering
PVC Gray

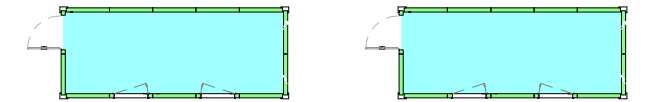

Ceiling covering
Chipboard white

Inner wall color
Chipboard white

View Back side
1 : 50

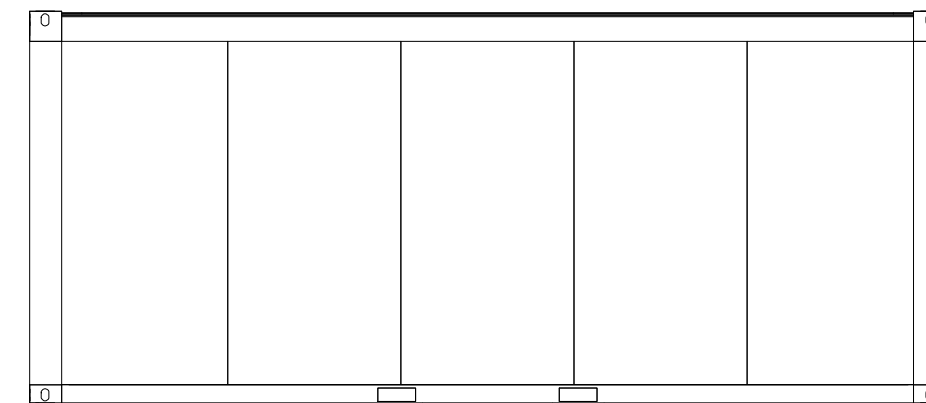

3D

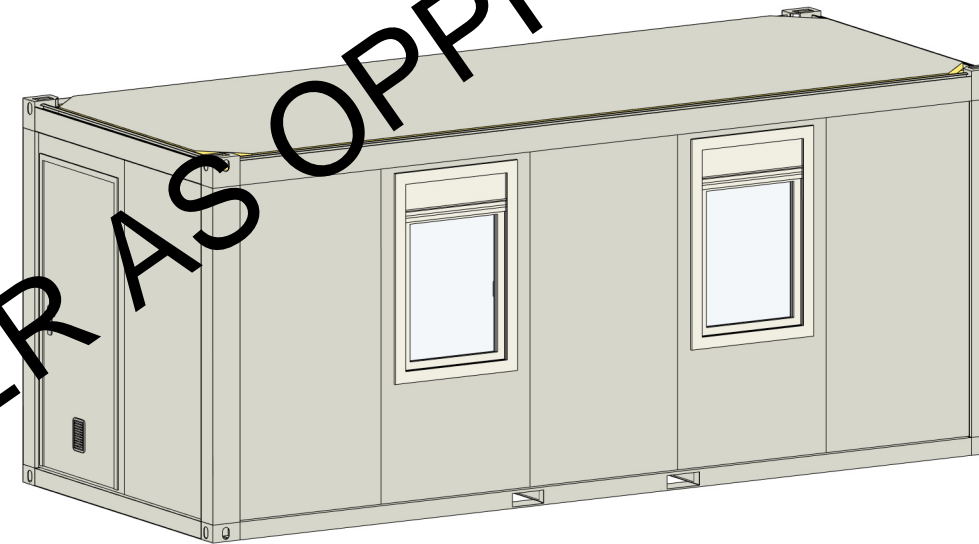

Pos.	Title	NET Dim.	Dim.	Material	Pcs.
D105	Door single AL(EPS), R	805x2000	905x2060	AL	1
W101	Window, with shutters, R		885x1372	PVC	1
W102	Window, with shutters, L		885x1372	PVC	1

View Left side
1 : 50

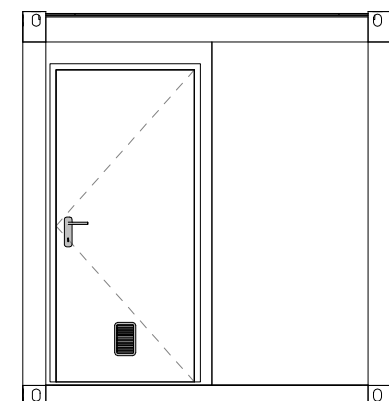

View Right side
1 : 50

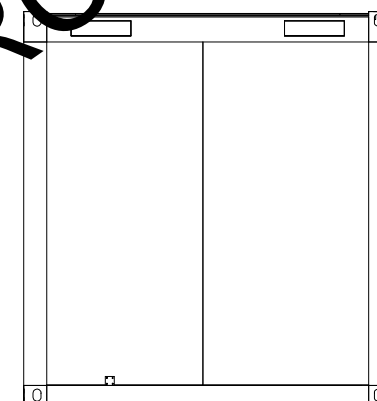

Interior Height
1 : 50

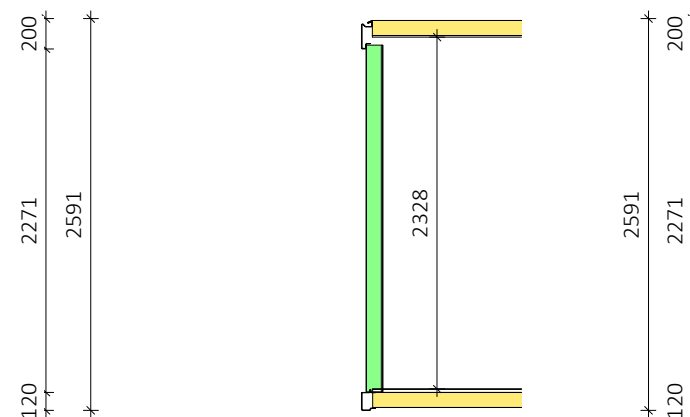

CONTAINER

WWW.RCONTAINER.NO



KONTOR-LAGER-WC-AGGREGATER

Light type		Pcs.
Fluo light 1x58W		2
Electrical equipment		Pcs.
Heater el. 2kW		1
Socket Double IP20		2
Socket IP20		1
Switch IP20		1
Panel Type		Insulation Stk.
FTVL-100 [9002/white]		100mm 14

Customer: Drwg. name: Plan with views Object: 20' ctn Ref. number: D-110618-1 Date: 11.6.2018	Drwg. Nr.: N-91577-18-01 Version.: 01 Scale: As indicated Designed: Approved:	Labels Plumbing System Electric Type Forklift Roof Insulation Floor Insulation Frame Galvaniz. Frame Colour Interior Height Export of CTN	Rcontainer AS / No norm 230V 250x90-1200mm 100mm 100mm / RAL 9002 2,326m Trans-pack
--	--	--	--